

SAW RESONATOR Part Number : VTR41755

The VTR41755 is a true one-port, surface-acoustic-wave (SAW) resonator in a surface-mount ceramic QCC8C case. It provides reliable, fundamental-mode, quartz frequency stabilization i.e. in transmitters or local oscillators operating at 417.500 MHz.

1. Package Dimension (QCC8C)

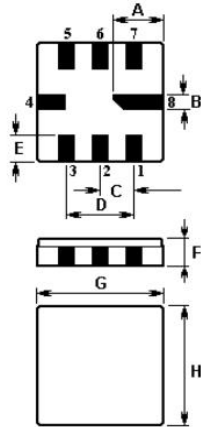

Pin	Configuration
2	Terminal1
6	Terminal2
4, 8	Case Ground
1, 3, 5, 7	Empty

Sign	Data (unit: mm)	Sign	Data (unit: mm)
A	2.08	E	1.2
B	0.6	F	1.35
C	1.27	G	5.0
D	2.54	H	5.0

2. Marking

**VTR
41755**
Laser Marking

3. Equivalent LC Model and Test Circuit

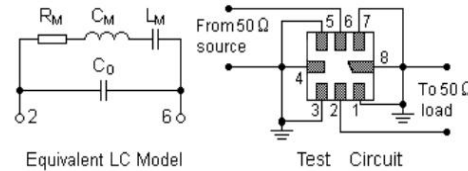

4. Typical Application Circuits

1) Low-Power Transmitter Application

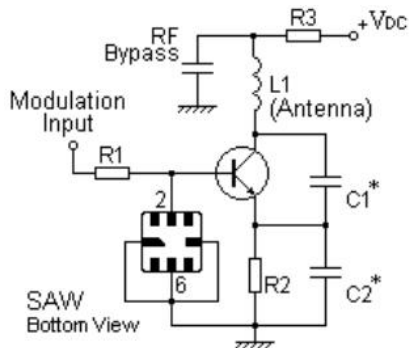

2) Local Oscillator Application

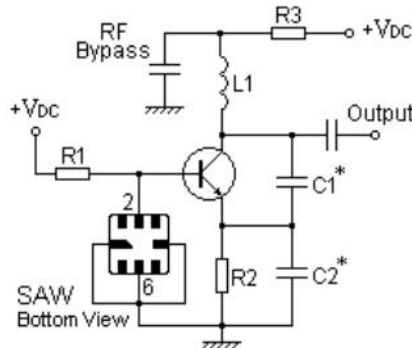

5. Typical Frequency Response

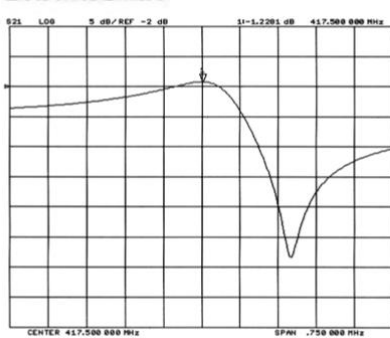

6. Temperature Characteristics

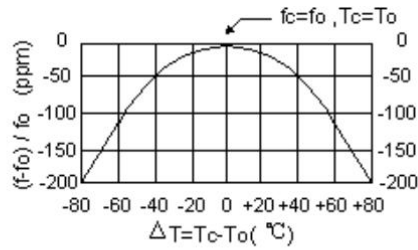

The curve shown above accounts for resonator contribution only and does not include oscillator temperature characteristics.

7. Performance

7-1. Maximum Ratings

Rating	Value	Unit
CW RF Power Dissipation P	0	dBm
DC Voltage Between Any two Pins V_{DC}	± 30	V
Storage Temperature Range T_{stg}	-40 to +85	$^{\circ}C$
Operating Temperature Range T_A	-10 to +60	$^{\circ}C$

7-2. Electronic Characteristics

Characteristic	Sym	Minimum	Typical	Maximum	Unit
Center Frequency (+25 $^{\circ}C$)	Absolute Frequency f_c	417.425		417.575	MHz
	Tolerance from 417.500 MHz Δf_c		± 75		kHz
Insertion Loss	IL		1.5	2.0	dB
Quality Factor	Unloaded Q Q_U		10,520		
	50 Ω Loaded Q Q_L		1,680		
Temperature Stability	Turnover Temperature T_0	25		55	$^{\circ}C$
	Turnover Frequency f_0		f_c		kHz
	Frequency Temperature Coefficient FTC		0.032		ppm/ $^{\circ}C^2$
Frequency Aging	Absolute Value during the First Year $ f_A $		≤ 10		ppm/yr
DC Insulation Resistance Between Any Two Terminals			1.0		M Ω
RF Equivalent RLC Model	Motional Resistance R_M		19	26	Ω
	Motional Inductance L_M		76.25005		μH
	Motional Capacitance C_M		1.9078		fF
	Shunt Static Capacitance C_0	1.80	2.05	2.30	pF

ⓘ CAUTION: Electrostatic Sensitive Device. Observe precautions for handling!

V.TORCH

1. The center frequency, f_c , is measured at the minimum IL point with the resonator in the 50Ω test system.
2. Unless noted otherwise, case temperature $T_c = +25^\circ\text{C} \pm 2^\circ\text{C}$.
3. Frequency aging is the change in f_c with time and is specified at $+65^\circ\text{C}$ or less. Aging may exceed the specification for prolonged temperatures above $+65^\circ\text{C}$. Typically, aging is greatest the first year after manufacture, decreasing in subsequent years.
4. Turnover temperature, T_0 , is the temperature of maximum (or turnover) frequency, f_0 . The nominal frequency at any case temperature, T_c , may be calculated from: $f = f_0 [1 - \text{FTC} (T_0 - T_c)^2]$.
5. This equivalent RLC model approximates resonator performance near the resonant frequency and is provided for reference only. The capacitance C_0 is the measured static (nonmotional) capacitance between Pin1 and Pin2. The measurement includes case parasitic capacitance.
6. Derived mathematically from one or more of the following directly measured parameters: f_c , IL, 3 dB bandwidth, f_c versus T_c , and C_0 .
7. The specifications of this device are based on the test circuit shown above and subject to change or obsolescence without notice.
8. Typically, equipment utilizing this device requires emissions testing and government approval, which is the responsibility of the equipment manufacturer.
9. Our liability is only assumed for the Surface Acoustic Wave (SAW) component(s) per se, not for applications, processes and circuits implemented within components or assemblies.
10. For questions on technology, prices and delivery, please contact our sales offices or e-mail info@vtorch.ca