

## SAW RESONATOR Part Number : VTR330M

The VTR330M is a true one-port, surface-acoustic-wave (SAW) resonator in a low-profile metal TO-39 case. It provides reliable, fundamental-mode, quartz frequency stabilization i.e. in transmitters or local oscillators operating at 330.000 MHz.

### 1. Package Dimension (TO-39)

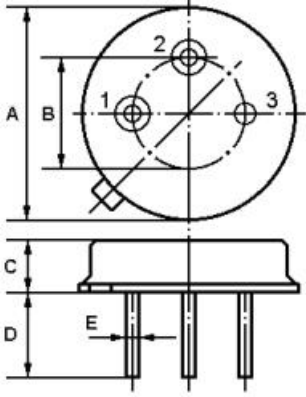

Pin	Configuration
1	Input / Output
2	Output / Input
3	Case Ground

Dimension	Data (unit: mm)
A	9.15±0.20
B	5.08±0.20
C	3.30±0.20
D	3±0.20 / 5±0.20
E	0.45±0.10

### 2. Marking

**VTR  
330M**

Ink Marking

Color: Black or Blue

### 3. Equivalent LC Model and Test Circuit

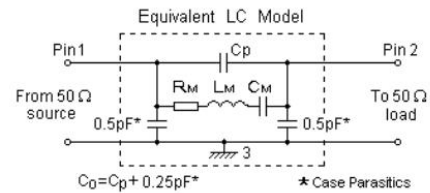

### 4. Typical Application Circuits

#### 1) Low-Power Transmitter Application

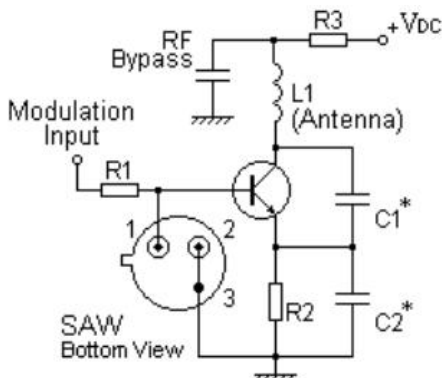

#### 2) Local Oscillator Application

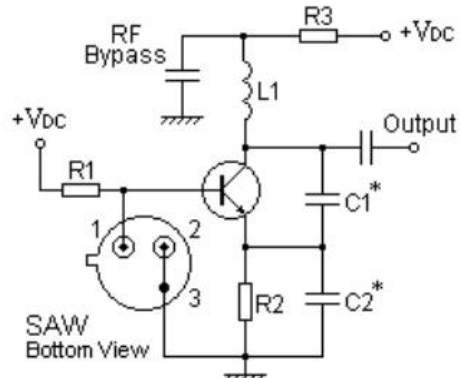

## 5. Typical Frequency Response

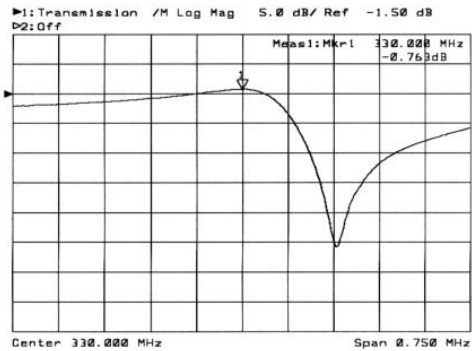

## 6. Temperature Characteristics

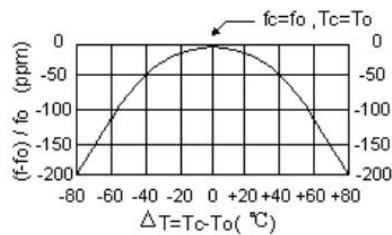

The curve shown above accounts for resonator contribution only and does not include oscillator temperature characteristics.

## 7.Performance

### 7-1.Maximum Ratings

Rating	Value	Unit
CW RF Power Dissipation $P$	0	dBm
DC Voltage Between Any two Pins $V_{DC}$	$\pm 30$	V
Storage Temperature Range $T_{stg}$	-40 to +85	$^{\circ}C$
Operating Temperature Range $T_A$	-10 to +60	$^{\circ}C$

### 7-2.Electronic Characteristics

Characteristic		Sym	Minimum	Typical	Maximum	Unit
Center Frequency (+25 $^{\circ}C$ )	Absolute Frequency	$f_c$	329.925		330.075	MHz
	Tolerance from 330.000 MHz	$\Delta f_c$		$\pm 75$		kHz
Insertion Loss		IL		1.2	1.8	dB
Quality Factor	Unloaded Q	$Q_U$		11,880		
	50 $\Omega$ Loaded Q	$Q_L$		1,550		
Temperature Stability	Turnover Temperature	$T_0$	25		55	$^{\circ}C$
	Turnover Frequency	$f_0$		$f_c$		kHz
	Frequency Temperature Coefficient	FTC		0.032		ppm/ $^{\circ}C^2$
Frequency Aging	Absolute Value during the First Year	$ f_A $		$\leq 10$		ppm/yr
DC Insulation Resistance Between Any Two Pins			1.0			M $\Omega$
RF Equivalent RLC Model	Motional Resistance	$R_M$		15	23	$\Omega$
	Motional Inductance	$L_M$		86.0114		$\mu H$
	Motional Capacitance	$C_M$		2.7071		fF
	Pin 1 to Pin 2 Static Capacitance	$C_0$	2.7	2.9	3.1	pF

**ⓘ CAUTION: Electrostatic Sensitive Device. Observe precautions for handling!**

# V.TORCH

1. The center frequency,  $f_c$ , is measured at the minimum IL point with the resonator in the  $50\Omega$  test system.
2. Unless noted otherwise, case temperature  $T_c = +25^\circ\text{C} \pm 2^\circ\text{C}$ .
3. Frequency aging is the change in  $f_c$  with time and is specified at  $+65^\circ\text{C}$  or less. Aging may exceed the specification for prolonged temperatures above  $+65^\circ\text{C}$ . Typically, aging is greatest the first year after manufacture, decreasing in subsequent years.
4. Turnover temperature,  $T_0$ , is the temperature of maximum (or turnover) frequency,  $f_0$ . The nominal frequency at any case temperature,  $T_c$ , may be calculated from:  $f = f_0 [1 - \text{FTC} (T_0 - T_c)^2]$ .
5. This equivalent RLC model approximates resonator performance near the resonant frequency and is provided for reference only. The capacitance  $C_0$  is the measured static (nonmotional) capacitance between Pin1 and Pin2. The measurement includes case parasitic capacitance.
6. Derived mathematically from one or more of the following directly measured parameters:  $f_c$ , IL, 3 dB bandwidth,  $f_c$  versus  $T_c$ , and  $C_0$ .
7. The specifications of this device are based on the test circuit shown above and subject to change or obsolescence without notice.
8. Typically, equipment utilizing this device requires emissions testing and government approval, which is the responsibility of the equipment manufacturer.
9. Our liability is only assumed for the Surface Acoustic Wave (SAW) component(s) per se, not for applications, processes and circuits implemented within components or assemblies.
10. For questions on technology, prices and delivery, please contact our sales offices or e-mail [info@vtorch.ca](mailto:info@vtorch.ca)